



**PARA LIGHT ELECTRONICS CO., LTD.**

4F, No.1, Lane 93, Chien Yi Road, Chung Ho City, Taipei, Taiwan.

Tel: 886-2-2225-3733

Fax: 886-2-2225-4800

E-mail: [para@para.com.tw](mailto:para@para.com.tw)

<http://www.para.com.tw>

**DATA SHEET**

**PART NO. : L51AGIR4C-150MA**

**REV : A / 0**

CUSTOMER'S APPROVAL: \_\_\_\_\_

DCC: \_\_\_\_\_



5.0mm INFRARED EMITTING DIODE

L51AGIR4C-150MA

REV:A / 0

PACKAGE DIMENSIONS

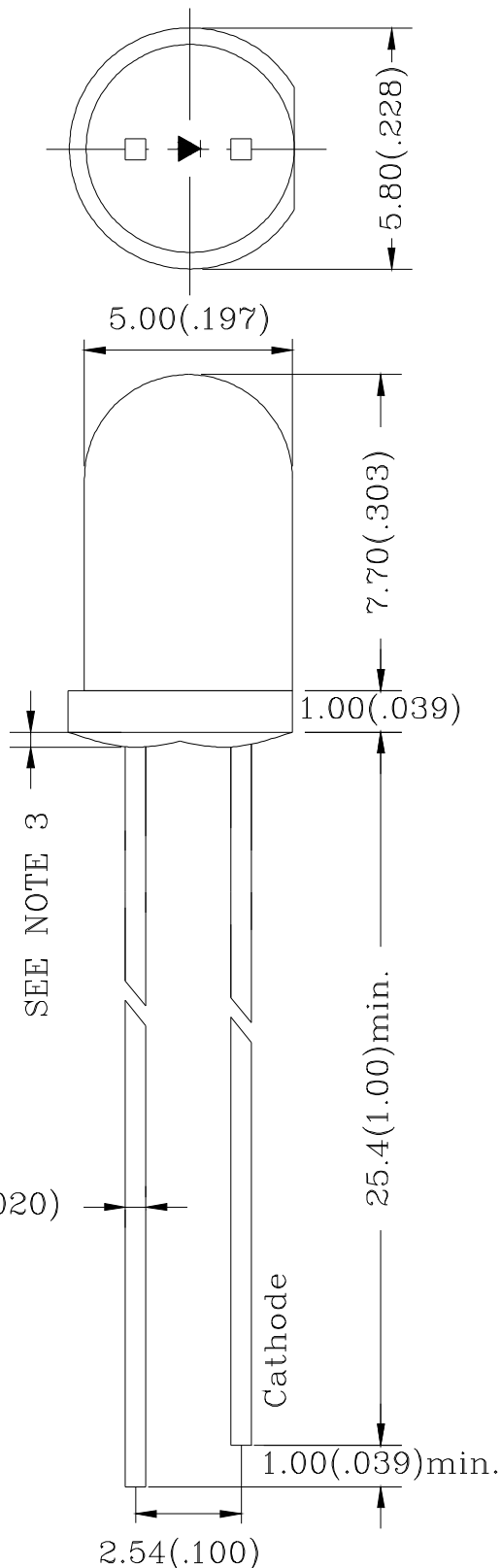

ITEM	MATERIALS
RESIN	Epoxy Resin
LEAD FRAME	Sn Plating iron Alloy

Note:

- 1.All Dimensions are in millimeters.
- 2.Tolerance is  $\pm 0.25\text{mm}(0.010 \text{ "})$   
Unless otherwise specified.
- 3.Protruded resin under flange is  $1.5\text{mm}(0.059 \text{ "})$  max.



5.0mm INFRARED EMITTING DIODE

L51AGIR4C-150MA

REV:A / 0

FEATURES

- \* High reliability
- \* Low-voltage characteristics
- \* Narrow view angle
- \* Pb FREE Products
- \* RoHS Compliant

CHIP MATERIALS

- \* Dice Material : GaAlAs/GaAlAs
- \* Lens Color : WATER CLEAR

ABSOLUTE MAXIMUM RATING : ( Ta = 25°C )

SYMBOL	PARAMETER	MAX	UNIT
PAD	Power Dissipation	240	mW
VR	Reverse Voltage	5	V
IF	Forward Current	120	mA
IPF	Peak forward current (300pps,10ms pulse)	1	A
Topr	Operating Temperature Range	-25°C to 85°C	
Tstg	Storage Temperature Range	-25°C to 85°C	

IFP Condition : Pulse Width≤10msec, 10% duty cycle

ELECTRO-OPTICAL CHARACTERISTICS : ( Ta = 25°C )

SYMBOL	PARAMETER	TEST CONDITION	MIN.	TYP.	MAX.	UNIT
VF	Forward Voltage	IF = 150mA		1.55	1.8	V
IR	Reverse Current	VR = 5V			10	mA
λP	Peak Emission Wavelength	IF = 150mA		850		nm
2θ1/2	Half Intensity Angle	IF = 100mA		50		deg
IE	Radiant Intensity	IF = 150mA		70		mw/sr



# 5.0mm INFRARED EMITTING DIODE

## L51AGIR4C-150MA

REV:A / 0

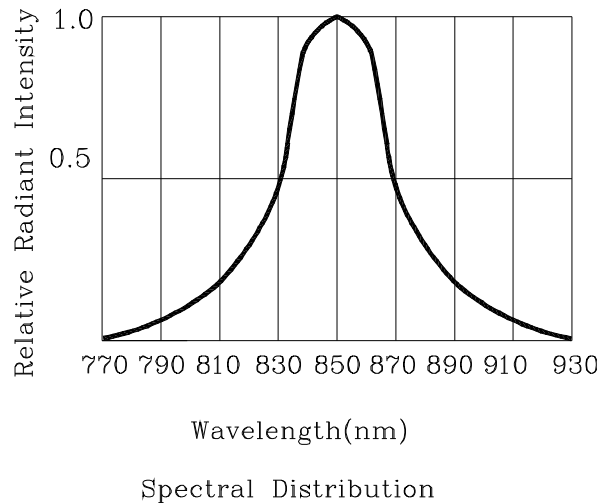
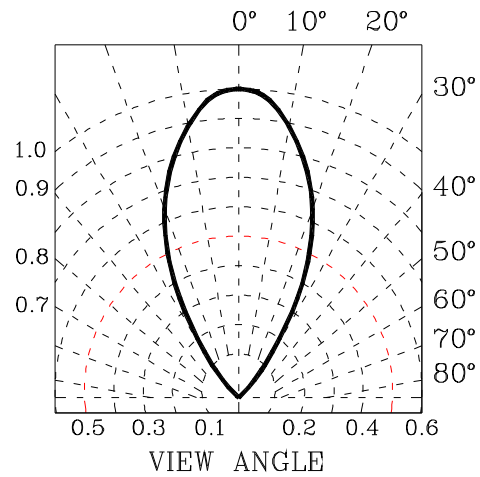
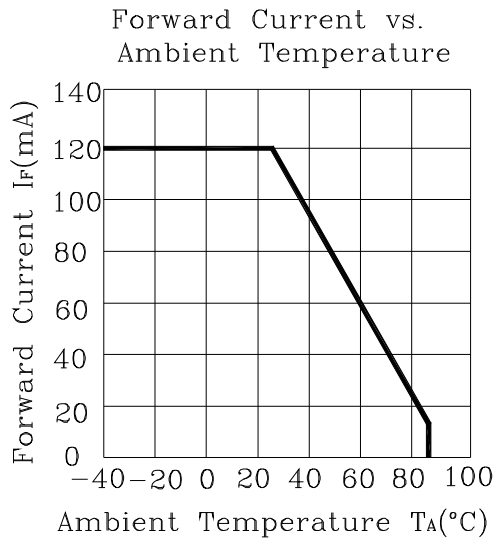
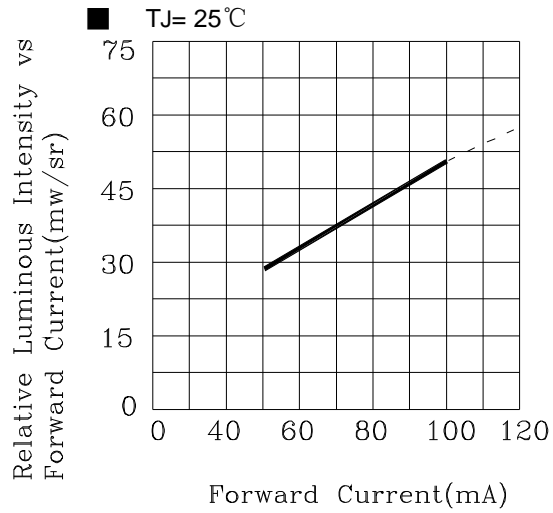
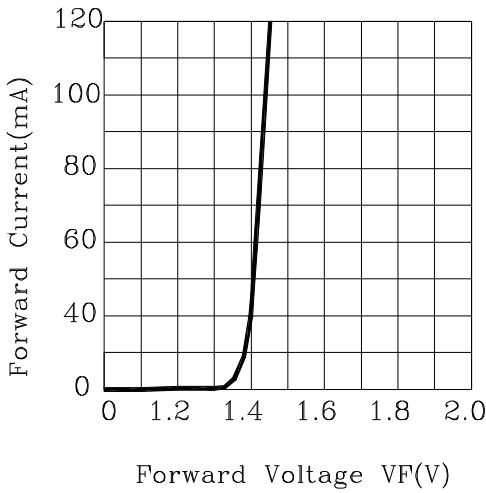



5.0mm INFRARED EMITTING DIODE

L51AGIR4C-150MA

REV:A / 0

Label Explanation

	光鼎电子股份有限公司 PARA LIGHT ELECTRONICS CO.,LTD.
PART NO	: L5PGEIR4C-Z-A-HB
LOT NO	: <span style="border: 1px solid black; padding: 2px;">INSPECTED</span>
BIN	: <span style="border: 1px solid black; padding: 2px;"></span>
Q' TY	: PCS
N. W	: g

PART NO. : L51AGIR4C-150MA

Refer to page 12

LOT NO. : E L L 4 7 0009

A B C D E F

A---E: For Serial number

B---L: Local F: Foreign

C---L: LAMP

D---Year

E---Month

F---Serial number

BIN : Bin Code List

Luminous Intensity(IE), Unit: mw/sr @150mA		
Bin Code	Min	Max
X	56	62
Y	62	68
Z	68	74
Z1	74	82
Z2	82	97

Tolerance of each bin are±15%

Luminous Intensity (VF), Unit:v@150mA		
Bin Code	Min	Max
A0	1.3	1.4
A	1.4	1.5
B	1.5	1.6
C	1.6	1.7
D	1.7	1.8

Tolerance of each bin are±0.1Volt



5.0mm INFRARED EMITTING DIODE

L51AGIR4C-150MA

REV:A / 0

**SOLDERING**

METHOD	SOLDERING CONDITIONS	REMARK
DIP SOLDERING	Bath temperature: 260°C Immersion time: within 5 sec, 1 time	– Solder no closer than 3mm from the base of the package – Using soldering flux, "RESIN FLUX" is recommended.
SOLDERING IRON	Soldering iron: 30W or smaller Temperature at tip of iron: 300°C or lower Soldering time: within 3 sec.	– During soldering, take care not to press the tip of iron against the lead. (To prevent heat from being transferred directly to the lead, hold the lead with a pair of tweezers while soldering)

1) When soldering the lead of LED in a condition that the package is fixed with a panel (See Fig.1), be careful not to stress the leads with iron tip.

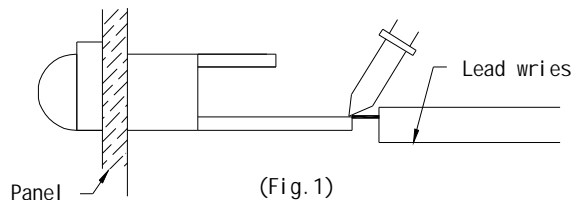

2) When soldering wire to the lead, work with a Fig (See Fig.2) to avoid stressing the package.

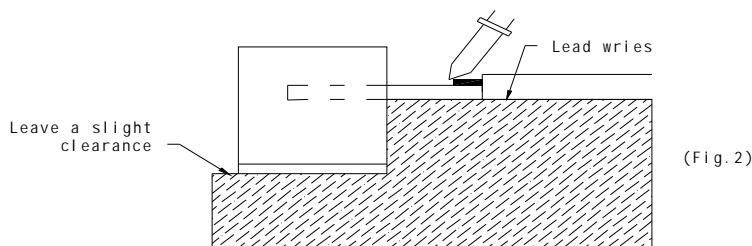

Regarding tinning the leads, compound made of tin ,copper and sliver is proposed with the temperature of 260°C. The proportion of the alloyed solution is 95.5% tin, 3.5 % copper, 0.5% silver. The time of tinning is 3 seconds.



5.0mm INFRARED EMITTING DIODE

L51AGIR4C-150MA

REV:A / 0

- 3) Similarly, when a jig is used to solder the LED to PC board, take care as much as possible to avoid stressing the leads (See Fig.3).

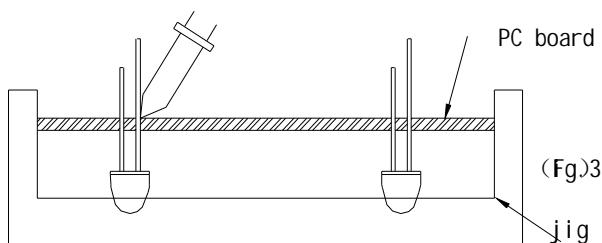

- 4) Repositioning after soldering should be avoided as much as possible. If inevitable: select a best-suited method that assures the least stress to the LED.
- 5) Lead cutting after soldering should be performed only after the LED temperature has returned to normal temperature.

#### — STORAGE

- 1) The LEDs should be stored at 30°C or less and 70% RH or less after being shipped from PARA and the storage life limit is 1 year .
- 2) PARA LED lead frames are comprised of a tin plated iron alloy. The surface may be affected by environments which contain corrosive gases and so on. Please avoid conditions which may cause the LEDs to corrode, tarnish or discolor. This corrosion or discoloration may cause difficulty during soldering operations. It is recommended that the LEDs be used as soon as possible.
- 3) Please avoid rapid changes in ambient temperature, especially, in high humidity environments where condensation can occur.



5.0mm INFRARED EMITTING DIODE

L51AGIR4C-150MA

REV:A / 0

— **STATIC ELECTRICITY**

- 1) Static electricity or surge voltage damages the LEDs.  
It is recommended that a wrist band and an anti-electrostatic glove be used when handling the LEDs.
- 2) All devices, equipment and machinery must be properly grounded. It is recommended that measures be taken against surge voltage to the LED mounting equipment.
- 3) When inspecting the final products in which LEDs were assembled, it is recommended to check whether the assembled LEDs are damaged by static electricity. To find static-damaged LEDs, perform a light-on test or a VF test at a lower current (below 1mA is recommended).
- 4) Damaged LEDs will show some unusual characteristics such as the leakage current remarkably increases, the forward voltage becomes lower, or the LEDs do not light at the low current.

Criteria : (  $V_F > 2.0V$  at  $I_F = 0.5mA$  )

— **LED MOUNTING METHOD**

- 1) When mounting the LED to a housing, as shown on Fig.4, ensure that the mounting holes on the PC board match the pitch of the leads correctly. Tolerance of dimensions of the respective components including the LEDs should be taken into account especially when designing the housing, PC board, etc. to prevent pitch misalignment between the leads and holes on PCB, the diameter of the holes should be slightly larger than the size of the lead. Alternatively, the shape of the holes could be made oval. (See Fig.4)

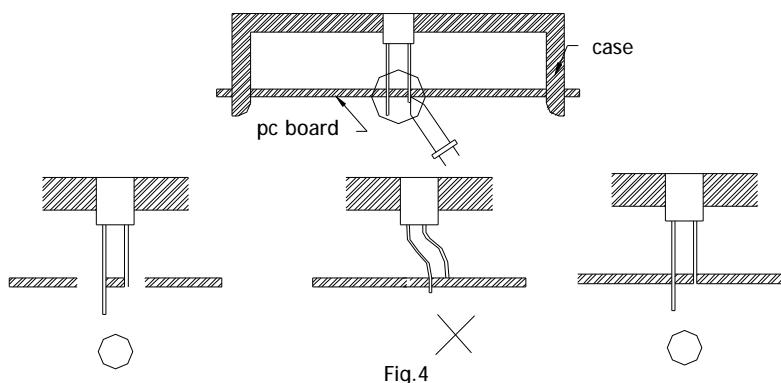

Fig.4





5.0mm INFRARED EMITTING DIODE

L51AGIR4C-150MA

REV:A / 0

- 2) Use LEDs with stand-off (Fig.5) or the tube or spacer made of plastic (Fig.6) to position the LEDs.

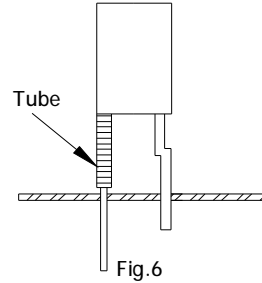
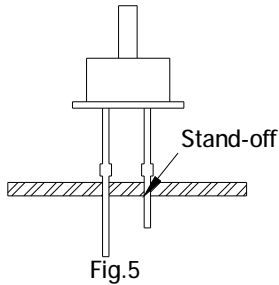

— FORMING LEAD

- 1) The lead should be bent at least 2mm away from the package. Bending should be performed with base fixed to a jig or pliers (Fig.7)

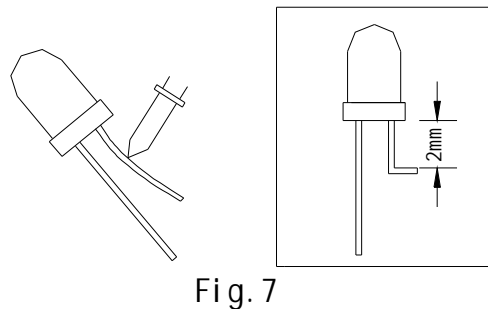

- 2) Forming lead should be carried out prior to soldering and never during or after soldering.  
3) Form the lead to ensure alignment between the leads and the holes on PCB, so that stress against the LED is prevented. (Fig.8)

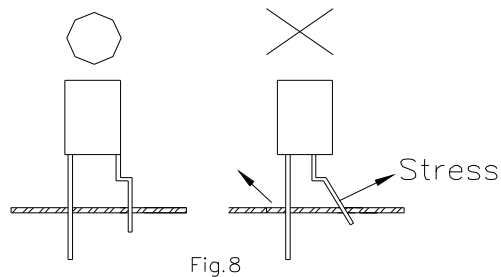



5.0mm INFRARED EMITTING DIODE

L51AGIR4C-150MA

REV:A / 0

**—LEAD STRENGTH**

1) Bend strength

Do not bend the lead more than twice. (Fig.9)

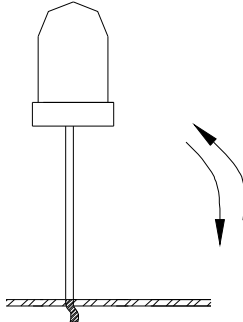

Fig.9

2) Tensile strength (@Room Temperature)

If the force is 1kg or less, there will be no problem. (Fig.10)

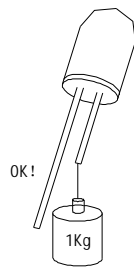

Fig.10

**—HEAT MANAGEMENT**

- 1) Thermal design of the end product is of paramount importance. Please consider the heat generation of the LED when designing the system. The temperature increase is affected by the thermal resistance of the circuit board and density of LED placement on the board, as well as other components. It is necessary to avoid intense heat generation and operate within the maximum ratings given in this specification.
- 2) The operating current (IF) should be decided after considering the ambient maximum temperature of LEDs.



5.0mm INFRARED EMITTING DIODE

L51AGIR4C-150MA

REV:A / 0

**—CHEMICAL RESISTANCE**

- 1) Avoid exposure to chemicals as it may attack the LED surface and cause discoloration.
- 2) When washing is required, refer to the following table for the proper chemical to be used.  
(Immersion time: within 3 minutes at room temperature.)

SOLVENT	ADAPTABILITY
Freon TE	⊙
Chlorothene	×
Isopropyl Alcohol	⊙
Thinner	×
Acetone	×
Trichloroethylene	×

NOTE: Influences of ultrasonic cleaning of the LED resin body differ depending on factors such as the oscillator output, size of the PC board and the way in which the LED is mounted. Therefore, ultrasonic cleaning should only be performed by confirming an ultrasonic cleaning trial run.

⊙--Usable    ×--Do not use.

**—OTHER CONSIDERTIONS**

- 1) Care must be taken to ensure that the reverse voltage will not exceed the absolute maximum rating when using the LEDs with matrix drive.
- 2) The LEDs described in this data sheet are intended to be used for ordinary electronic equipment (such as office equipment, communications equipment, measurement instruments and household appliances). Consult PARA's sales staff in advance for information on the applications in which exceptional quality and reliability are required , particularly when the failure or malfunction of the LEDs may directly jeopardize life or health (such as for airplanes, spacecraft, automobiles, traffic control equipment etc).
- 3) The formal specifications must be exchanged and signed by both parties before large volume purchase begins.



5.0mm INFRARED EMITTING DIODE

L51AGIR4C-150MA

REV:A / 0

### LED Lamps: Part Number Rules

