



PARA LIGHT ELECTRONICS CO., LTD.

11F., No. 8, Jiankang Rd., Zhonghe Dist., New Taipei City 235, Taiwan,

Tel: 886-2-2225-3733

Fax: 886-2-2225-4800

E-mail: para@para.com.tw

<http://www.para.com.tw>

DATA SHEET

PART NO.: L-C191LGCT-U1

REV: D / 0

CUSTOMER'S APPROVAL : _____

DCC : _____

DRAWING NO. : DS-74-04-0001

DATE : 2022-01-08

Page

1

● PACKAGE OUTLINE DIMENSIONS

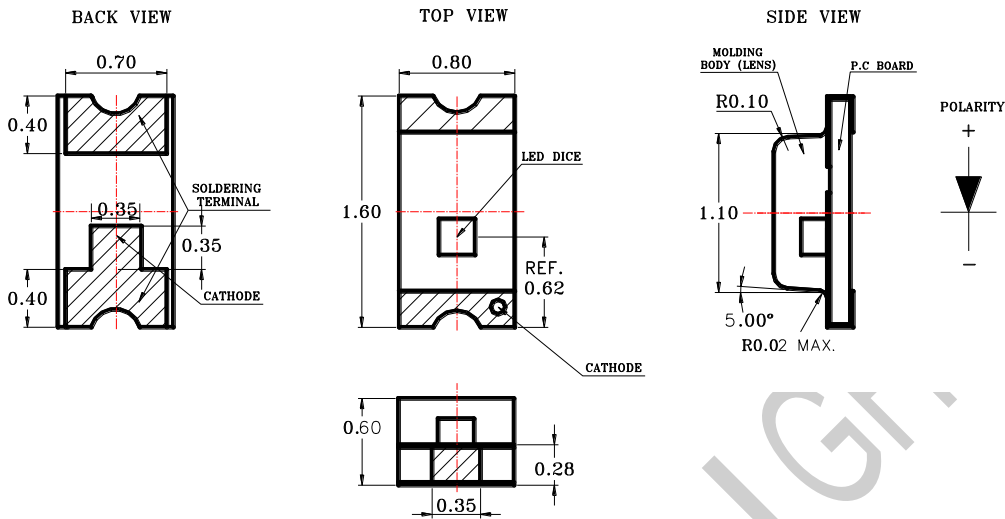

Notes:

1. All dimensions are in millimeters.
2. Tolerance is $\pm 0.1\text{mm}$ (.004") unless otherwise noted.

● Features

- * Top view, wide view angle, single color Chip LED.
- * Package in 8mm tape on 7" diameter reels.
- * Compatible with automatic Pick & Place equipment.
- * Compatible with Infrared and Wave soldering reflow solder processes.
- * EIA STD package.
- * I.C. compatible.
- * Pb free product.
- * Meet RoHS Green Product.
- * MSL-3

● **Chip Materials**

- * Dice Material : InGaN
- * Light Color : Super Green
- * Lens Color : Water Clear

● **Absolute Maximum Ratings(Ta=25°C)**

Symbol	Parameter	Rating	Unit
PD	Power Dissipation	100	mW
IPF	Peak Forward Current (1/10 Duty Cycle, 0.1ms Pulse Width)	100	mA
IF	Continuous Forward Current	25	mA
-	De-rating Linear From 25°C	0.25	mA/°C
VR	Reverse Voltage	5	V
ESD	Electrostatic Discharge Threshold(HBM)Note A	1000	V
Topr	Operating Temperature Range	-40 ~ +85	°C
Tstg	Storage Temperature Range	-40 ~ +85	°C

Note A :

HBM : Human Body Model. Seller gives no other assurances regarding the ability of to withstand ESD.

● **Electro-Optical Characteristics(Ta=25°C)**

Parameter	Symbol	Min.	Typ.	Max.	Unit	Test Condition
Luminous Intensity	IV	280	700	1120	mcd	IF=20mA
Viewing Angle	2 θ 1/2		130		deg	Note 2
Peak Emission Wavelength	λ p		518		nm	Measurement @Peak
Dominant Wavelength	λ d	520	525	530	nm	IF=20mA
Spectral Line Half-Width	Δ λ		15		nm	
Forward Voltage	VF	2.95	3.1	3.55	V	IF =20mA
Reverse Current	IR			50	μ A	VR = 5V

● **Bin Code List**

Luminous Intensity(IV), Unit:mcd@20mA		
Bin Code	Min	Max
T	280	450
U	450	710
V	710	1120

Forward Voltage(VF), Unit:V@20mA		
Bin Code	Min	Max
K9	2.95	3.10
K10	3.10	3.25
K11	3.25	3.40
K12	3.40	3.55

Tolerance of each bin are $\pm 15\%$

Tolerance of each bin are ± 0.1 Volt

Dominant Wavelength (Hue),Unit: nm@20mA		
Bin Code	Min	Max
AP	520	525
AQ	525	530

Tolerance of each bin are ± 1 nm

Notes:

1. Luminous intensity is measured with a light sensor and filter combination that proximities the CIE eye-response curve.
2. $\theta 1/2$ is the off-axis angle at which the luminous intensity is half the axial luminous intensity.
3. The dominant wavelength λd is derived from the CIE chromaticity diagram and represents the single wavelength which defines the color of the device.
4. Caution in ESD :
Static Electricity and surge damages the LED. It is recommended use a wrist band or anti-electrostatic glove when handling the LED. All devices, equipment and machinery must be properly grounded.
5. Major standard testing equipment by “Instrument System” Model : CAS140B Compact Array Spectrometer and “KEITHLEY” Source Meter Model : 2400.

● Typical Electro-Optical Characteristics Curves

(25°C Ambient Temperature Unless Otherwise Noted)

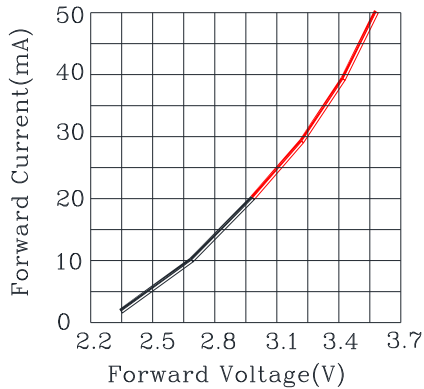

Fig.2 Forward Current vs. Forward Voltage

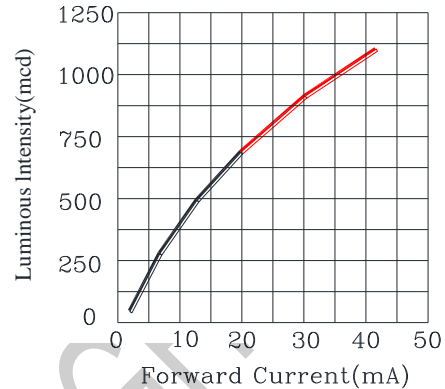

Fig.3 Luminous Intensity vs. Forward Current

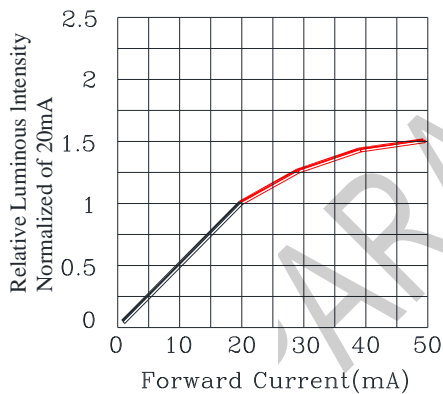

Fig.4 Relative Luminous Intensity vs. Forward Current

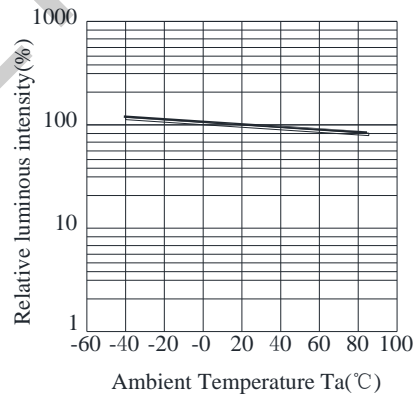

Fig.5 Luminous Intensity vs. Ambient Temperature

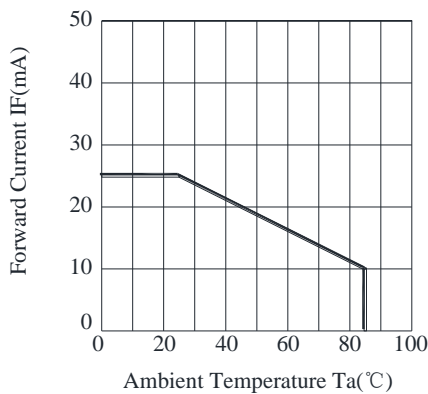

Fig.6 Forward Current Derating Curve

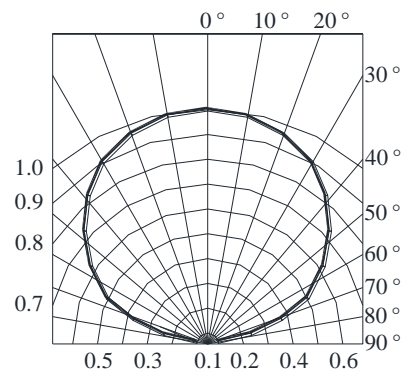

Fig.7 Relative Intensity vs. Angle



SURFACE MOUNT DEVICE LED

Part No. : L-C191LGCT-U1

REV:D / 0

● Label Explanation



ITEM CODE:PARRA LIGHT

PART NO: L-C191LGCT-U1

IV --- Luminous Intensity Code

LOT NO: EM S L 12 09 0110
 A B C D E F

A---EM: Emos Code

B---S:SMD

L---Local

D---Year

E---Month

F---SPEC.

PACKING QUANTITY OF BAG :

3000pcs for 150、170、110、155、115 series

4000pcs for 191 series

5000pcs for 192 series

DATE CODE: 2012 09 10
 G H I

G--- Year

H--- Month

I --- Day

● Typical Electro-Optical Characteristics Curves

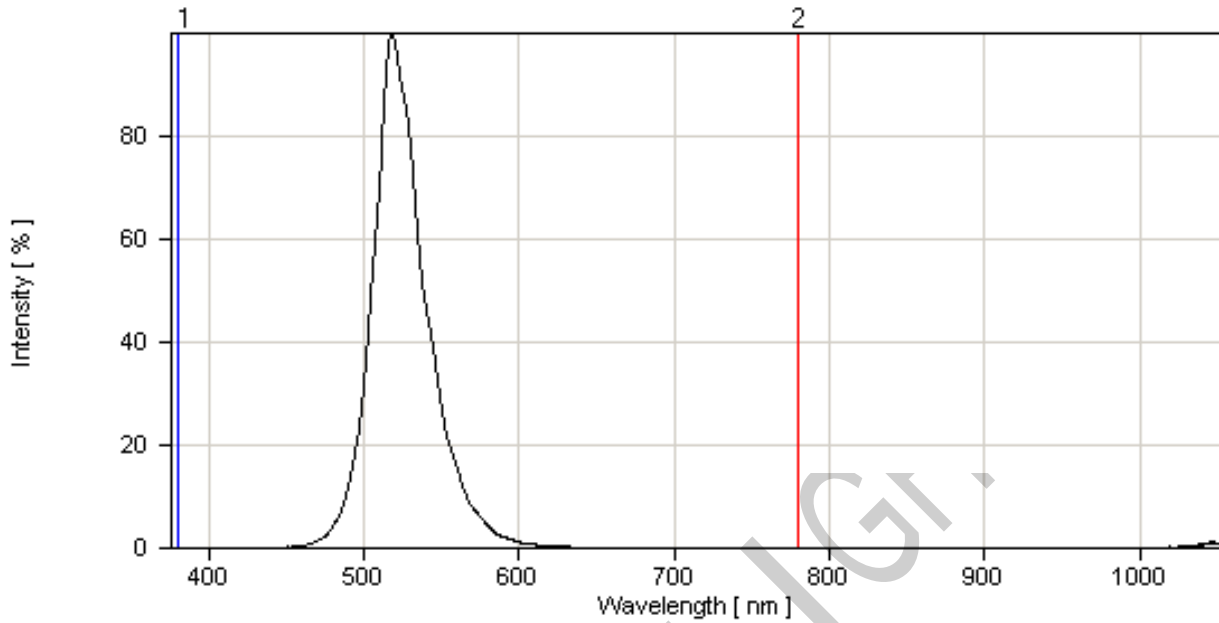
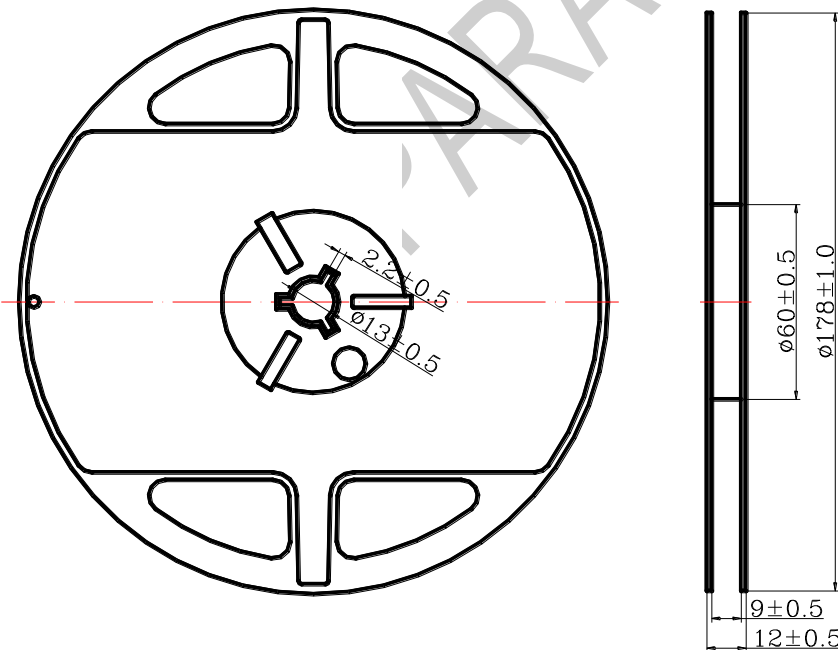

Fig.1 Relative Intensity vs. Wavelength

● Reel Dimensions



Notes:

1. Taping Quantity : 4000pcs
2. The tolerances unless mentioned is $\pm 0.1\text{mm}$, Angle $\pm 0.5^\circ$, Unit : mm.

● Package Dimensions Of Tape And Reel

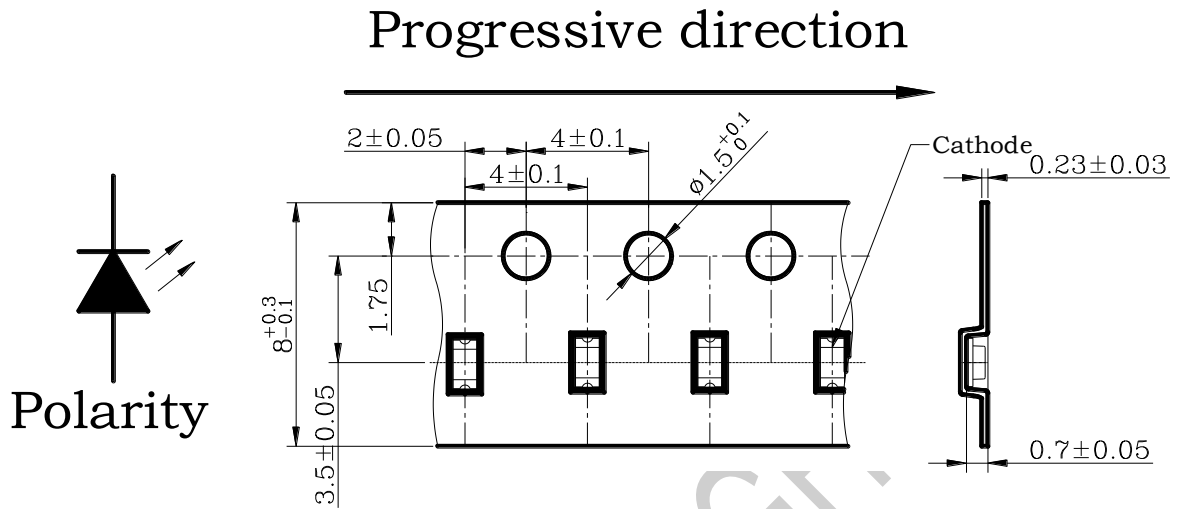

Notes: All dimensions are in millimeters.

● Cleaning

- * If cleaning is required , use the following solutions for less than 1 minute and less than 40°C.
- * Appropriate chemicals: Ethyl alcohol and isopropyl alcohol.
- * Effect of ultrasonic cleaning on the LED resin body differs depending on such factors as the oscillator output, size of PCB and LED mounting method. The use of ultrasonic cleaning should be enforced at proper output after confirming there is no problem.

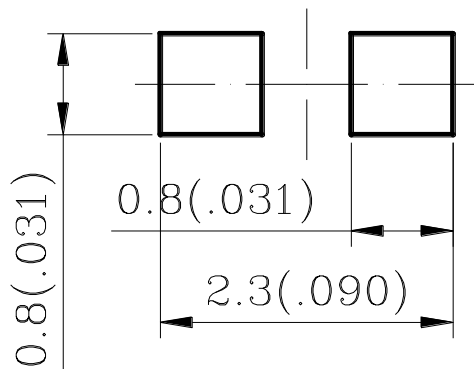
● Suggest Soldering Pad Dimensions

Direction of PWB camber
and go to reflow furnace

● Suggest Sn/Pb IR Reflow Soldering Profile Condition:

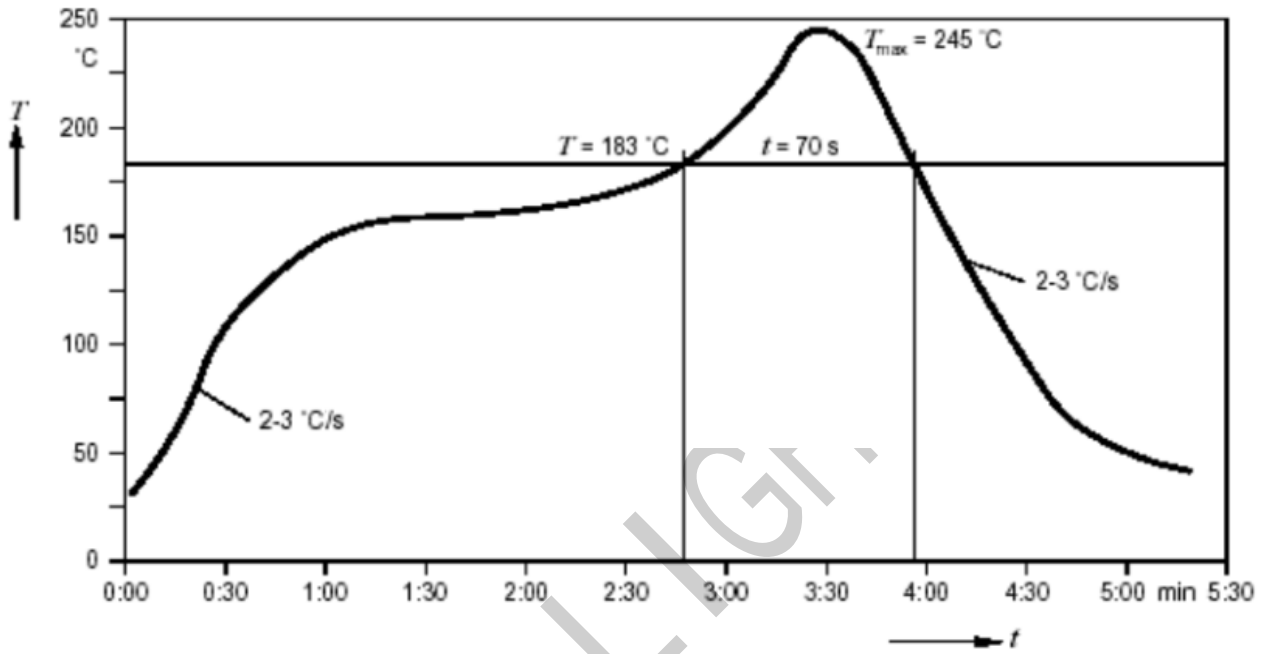

● Suggest Pb-Free IR Reflow Soldering Profile Condition:

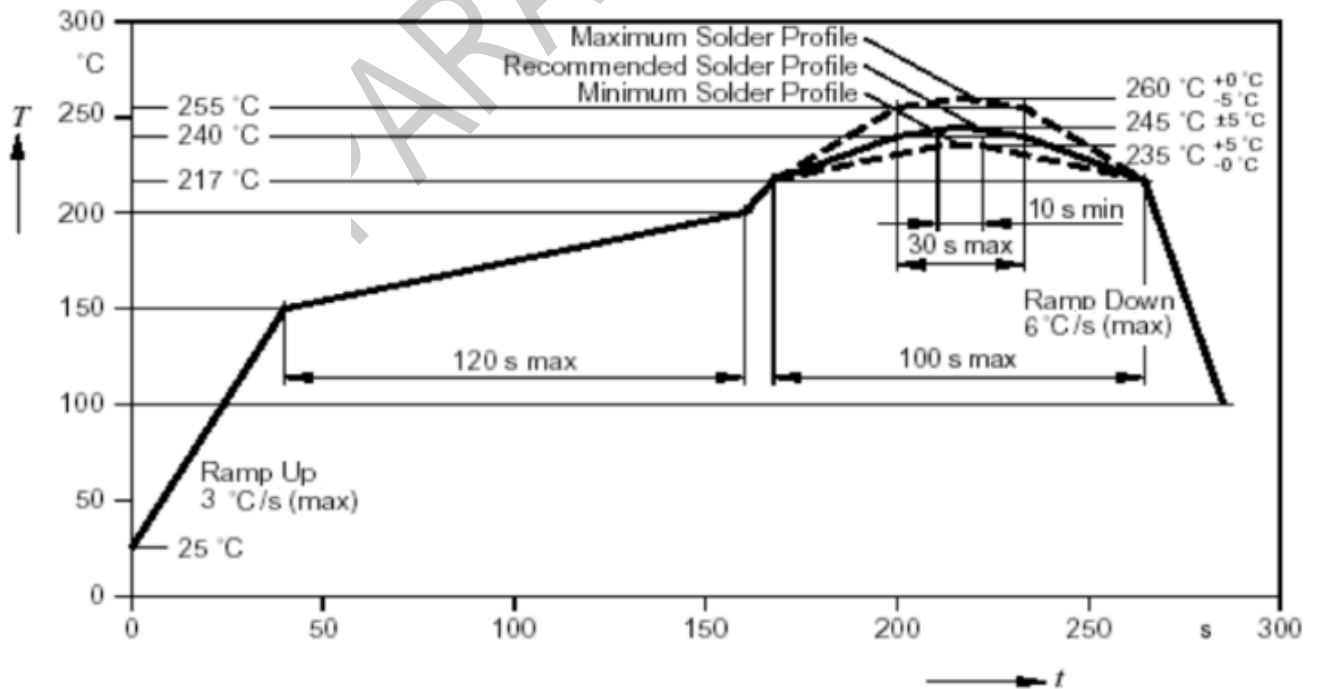

● CAUTIONS

1.Application Limitation :

The LED's described here are intended to be used for ordinary electronic equipment (such as office equipment, communication equipment and household application). Consult PARA's sales in advance for information on application in which exceptional quality and reliability are required, particularly when the failure or malfunction of the LED's may directly jeopardize life or health (such as airplanes, automobiles, traffic control equipment, life support system and safety devices).

2.Storage :

Do not open moisture proof bag before the products are ready to use.

Before opening the package: The LEDs should be kept at 30°C or less and 90%RH or less.

If the moisture absorbent material (silica gel) has faded away or the LEDs have exceeded the storage time, baking treatment should be performed using the following conditions.

Baking treatment: 60±5°C for 24 hours

3.Soldering

Do not apply any stress to the lead frame during soldering while the LED is at high temperature.

Recommended soldering condition.

Reflow Soldering :

Pre-heat 120~150 °C, 120sec. MAX., Peak temperature : 240 °C Max. Soldering time : 10 sec Max.

Soldering Iron : (Not recommended)

Temperature 300 °C Max., Soldering time : 3 sec. Max.(one time only), power dissipation of iron : 20W Max. use SN60 solder of solder with silver content and don't to touch LED lens when soldering.

Wave soldering :

Pre-heat 100 °C Max, Pre-heat time 60 sec. Max, Solder wave 260 °C Max, Soldering time 5 sec. Max. performed consecutively cooling process is required between 1st and 2nd soldering processes.

4. Lead-Free Soldering

For Reflow Soldering :

- 1、 Pre-Heat Temp:150-180°C,120sec.Max.
- 2、 Soldering Temp:Temperature Of Soldering Pot Over 230°C,40sec.Max.
- 3、 Peak Temperature:260°C , 5sec.
- 4、 Reflow Repetition:2 Times Max.
- 5、 Suggest Solder Paste Formula 93.3 Sn/3.1 Ag/3.1 Bi /0.5 Cu

For Soldering Iron (Not Recommended) :

- 1、 Iron Tip Temp:350°C Max.
- 2、 Soldering Iron:30w Max.
- 3、 Soldering Time:3 Sec. Max. One Time.

For Dip Soldering :

- 1、 Pre-Heat Temp:150°C Max. 120 Sec. Max.
- 2、 Bath Temp:265°C Max.
- 3、 Dip Time:5 Sec. Max.

5. Drive Method

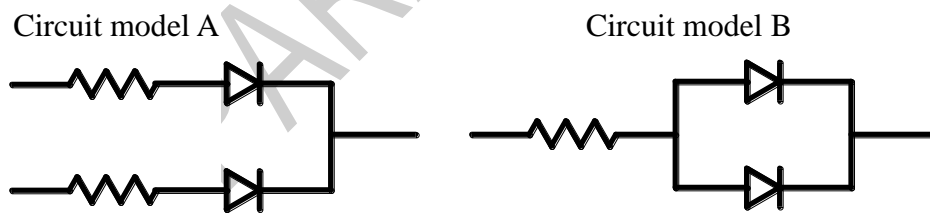

(A)Recommended circuit.

(B)The difference of brightness between LED`s could be found due to the Vf-If characteristics of LED.