



PARA LIGHT ELECTRONICS CO., LTD.

11F., No. 8, Jiankang Rd., Zhonghe Dist., New Taipei City 235, Taiwan,

Tel: 886-2-2225-3733

Fax: 886-2-2225-4800

E-mail: para@para.com.tw

<http://www.para.com.tw>

DATA SHEET

PART NO. : LH33C204D-HTS

REV : B/0

CUSTOMER'S APPROVAL : _____

DCC : _____

PACKAGE DIMENSIONS

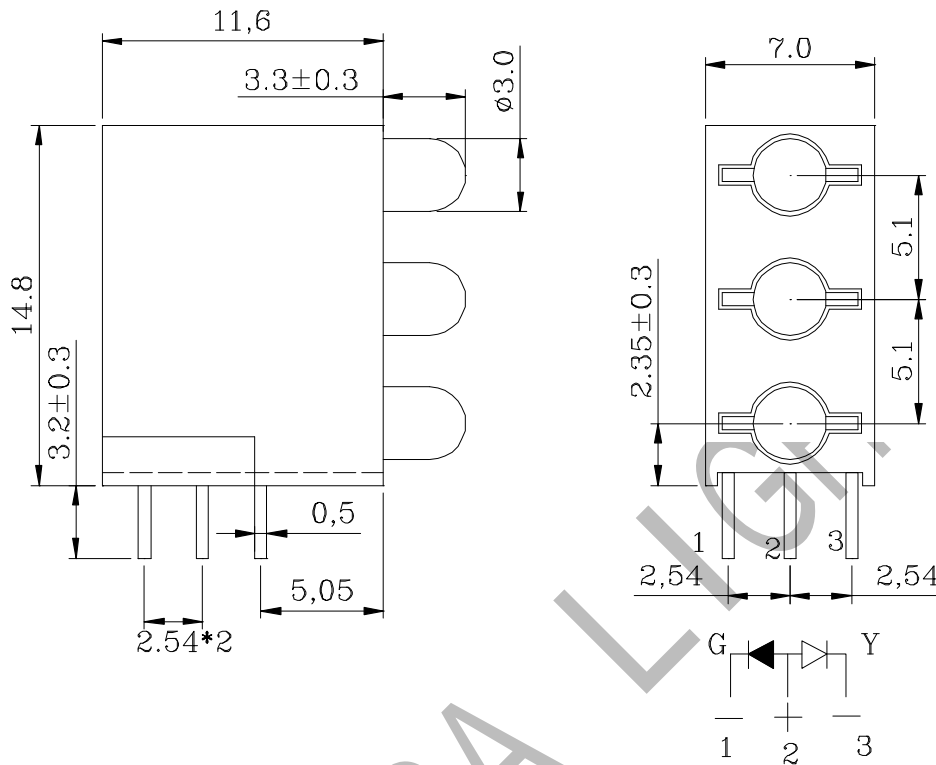

Note:

- 1.All Dimensions are in millimeters.
- 2.Tolerance is $\pm 0.25\text{mm}(0.010\text{ ''})$
Unless otherwise specified.
- 3.Protruded resin under flange
is $1.5\text{mm}(0.059\text{ ''})$ max.
- 4.Lead spacing is measured where
the leads emerge from the package.
- 5.Specification are subject to change
without notice
- 6.The lamps have sharp and hard points that
may injure human eyes or fingers etc., so
please pay enough care in the handling.
7. A=B=C=L329YGW-CA1-DP2.0-HTS-A 反穿



3.0 mm LED LAMP WITH LHY3303-9A/B-V0 HOLDER

LH33C204D-HTS

REV:B/ 0

FEATURES

- * 3.0mm DIA LED LAMP
- * LOW POWER CONSUMPTION.
- * I.C. COMPATIBLE.
- * LONG LIFE SOLID STATE RELIABILITY.
- * PB FREE PRODUCTS(Compliant with EU's RoHS.)

CHIP MATERIALS

- * Dice Material : GaAlInP/GaAs & GaAlInP/GaAs
- * Light Color : YELLOW & YELLOW Green
- * Lens Color : White Diffused

ABSOLUTE MAXIMUM RATING : (Ta = 25°C)

SYMBOL	PARAMETER	Yellow	Yellow Green	UNIT
PAD	Power Dissipation	78	78	mW
VR	Reverse Voltage	5	5	V
IF	Average Forward Current(Duty=0.1,1KHZ)	30	30	mA
IPF	Peak Forward Current Per Chip (Duty=0.1,1KHz)	120	120	mA
—	Derating Linear From 25°C	0.30	0.30	mA/°C
Topr	Operating Temperature Range	-40°C to 85°C		
Tstg	Storage Temperature Range	-40°C to 85°C		

ELECTRO-OPTICAL CHARACTERISTICS : (Ta = 25°C)

SYMBOL	DESCRIPTION	TEST CONDITION	MIN.	TYP.	MAX.	UNIT	
Vf	Forward Voltage	IF=20mA	Yellow	1.6	2.0	2.6	V
			Yellow Green	1.6	2.0	2.6	
IR	Reverse Current	VR=5 V	Yellow			100	μA
			Yellow Green			100	
λd	Dominant Wavelength	IF=20mA	Yellow	580	587	595	nm
			Yellow Green	560	570	575	
Δλ	Spectral Line Half-Width	IF=20mA	Yellow		15		nm
			Yellow Green		30		
2θ 1/2	Half Intensity Angle	IF=20mA	Y/G	80		deg	
Iv	Luminous Intensity	IF=20mA	Yellow	3.9	8	21.1	mcd
			Yellow Green	2.0	5	15.1	

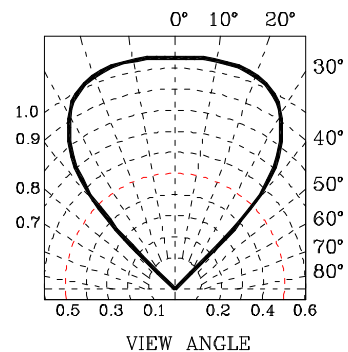
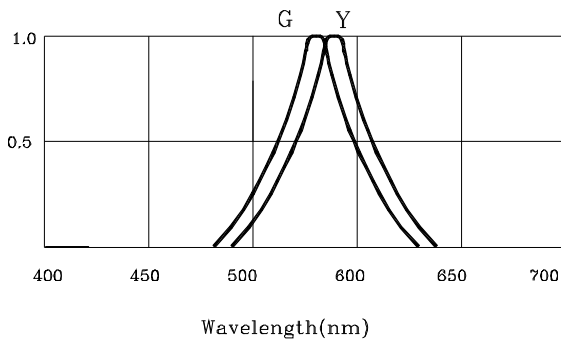
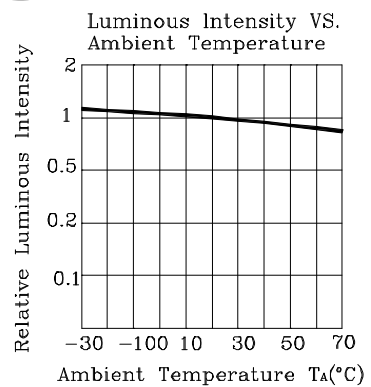
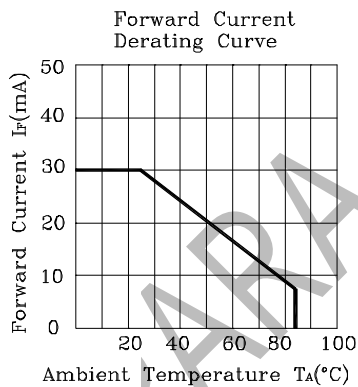
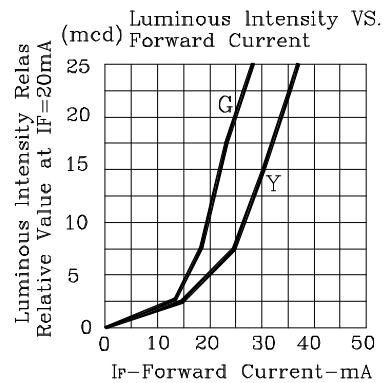
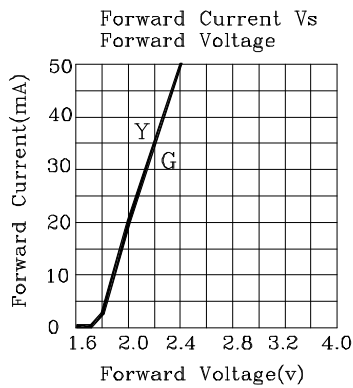



**3.0 mm LED LAMP WITH
LHY3303-9A/B-V0 HOLDER**

LH33C204D-HTS

REV:B/ 0

Label Explanation

		光鼎电子股份有限公司 PARA LIGHT ELECTRONICS CO.,LTD.	
PARA NO. :			
LOT NO. :		INSPECTED	
BIN :			
Q' TY :		PCS	
N. W :		g	

PARA NO. : Refer to p13

LOT NO. : **E L L 4 7 0009**

A B C D E F

A---E: For series number

B---L: Local F: Foreign

C---L: LAMP

D---Year

E---Month

F---SPEC.

N'W : Net Weight

•SOLDERING

METHOD	SOLDERING CONDITIONS	REMARK
DIP SOLDERING	Bath temperature:260°C Immersion time: with 10 sec, 1 time	<ul style="list-style-type: none"> Solder no closer than 3mm from the base of the package Using soldering flux," RESIN FLUX" is recommended. Attached data of temperature cure for your reference
Preheat Temperature	Preheat temperature: 100-130 sec(105°C max)	
SOLDERING IRON	Soldering iron: 30W or smaller Temperature at tip of iron: 380°C or lower Soldering time: within 10 sec.	<ul style="list-style-type: none"> During soldering, take care not to press the tip of iron against the lead.To prevent heat from being transferred directly to the lead, hold the lead with a pair of tweezers while soldering

1) When soldering the lead of LED in a condition that the package is fixed with a panel (See Fig.1), be careful not to stress the leads with iron tip.

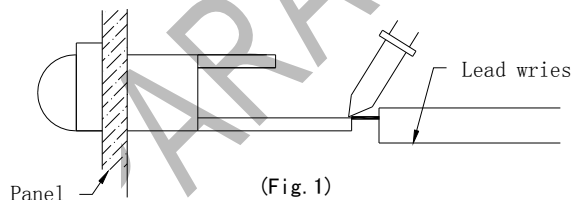

2) When soldering wire to the lead, work with a Fig (See Fig.2) to avoid stressing the package.

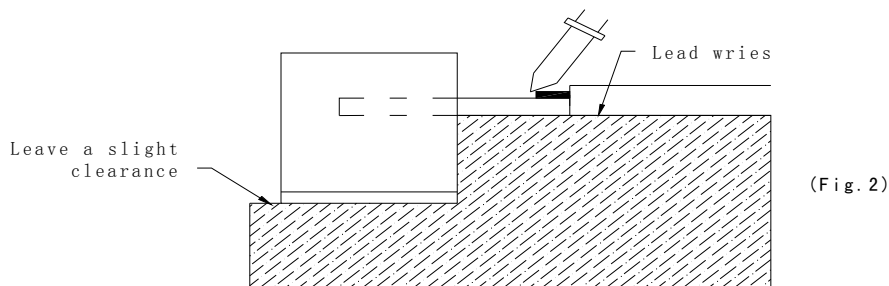

Regarding solution in the tinning oven for product-tinning, compound sub-solution made of tin & copper and silver is proposed with the temperature of Celsius 260. The proportion of the alloyed solution is tin 95.5: copper 3.5: silver 0.5 by percentage. The time of tinning is constantly 3 seconds.

- 3) Similarly, when a jig is used to solder the LED to PC board, take care as much as possible to avoid steering the leads (See Fig.3).

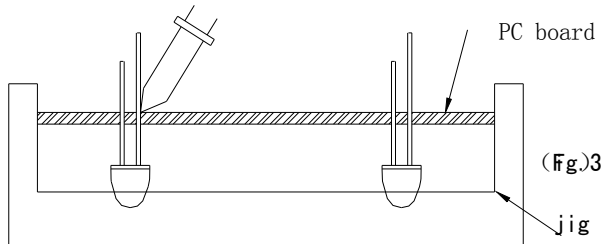

- 4) Repositioning after soldering should be avoided as much as possible. If inevitable, be sure to preserve the soldering conditions with irons stated above: select a best-suited method that assures the least stress to the LED.
- 5) Lead cutting after soldering should be performed only after the LED temperature has returned to normal temperature.

● STORAGE

- 1) The LEDs should be stored at 30°C or less and 75% RH or less after being shipped from PARA and the storage life limits are 3 months .
- 2) PARA LED lead frames are comprised of a stannum plated iron alloy. The silver surface may be affected by environments which contain corrosive gases and so on. Please avoid conditions which may cause the LEDs to corrode, tarnish or discolor. This corrosion or discoloration may cause difficulty during soldering operations. It is recommended that the LEDs be used as soon as possible.

Please avoid rapid transitions in ambient temperature, especially, in high humidity environments where condensation can occur.

•LED MOUNTING METHOD

- 3) When mounting the LED by using a case, as shown Fig.4, ensure that the mounting holds on the PC board match the pitch of the leads correctly-tolerance of dimensions of the respective components including the LED should be taken into account especially when designing the case, PC board, etc. to prevent pitch misalignment between the leads and board holes, the diameter of the board holes should be slightly larger than the size of the lead. Alternatively, the shape of the holes should be made oval. (See Fig.4)

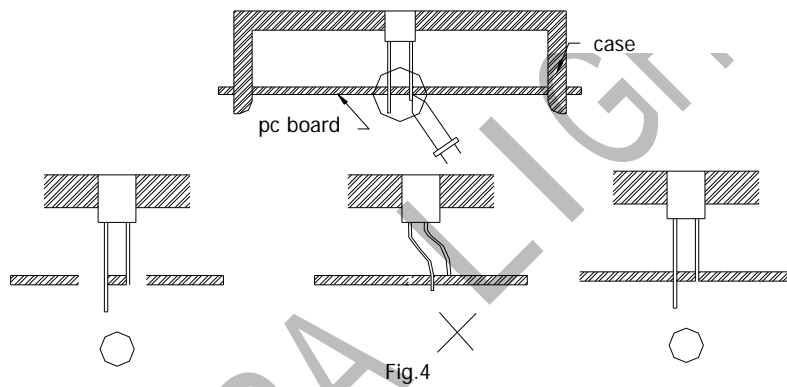

- 4) Use LEDs with stand-off (Fig.5) or the tube or spacer made of resin (Fig.6) to position the LEDs.

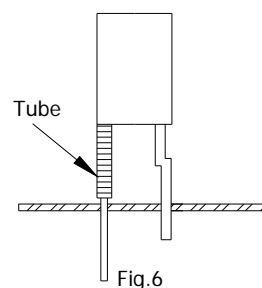
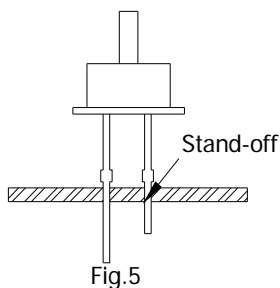

●FORMED LEAD

- 1) The lead should be bent at a point located at least 2mm away from the package. Bending should be performed with base fixed means of a jig or pliers (Fig.7)

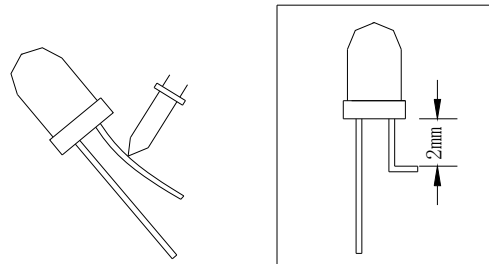

Fig. 7

- 2) Forming lead should be carried out prior to soldering and never during or after soldering.
- 3) Form the lead to ensure alignment between the leads and the hole on board, so that stress against the LED is prevented. (Fig.8)

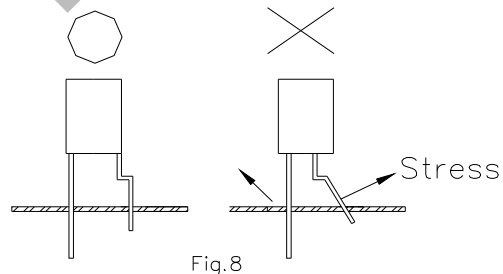

Fig.8

●LEAD STRENGTH

- 1) Bend strength
Do not bend the lead more than twice. (Fig.9)

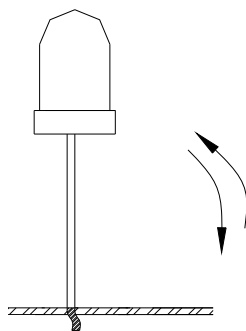
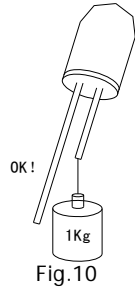

Fig.9

2) Tensile strength (@Room Temperature)

If the force is 1kg or less, there will be no problem. (Fig.10)



• HEAT GENERATION

- 1) Thermal design of the end product is of paramount importance. Please consider the heat generation of the LED when making the system design. The coefficient of temperature increase per input electric power is affected by the thermal resistance of the circuit board and density of LED placement on the board, as well as other components. It is necessary to avoid intense heat generation and operate within the maximum ratings given in this specification.

The operating current should be decided after considering the ambient maximum temperature of LEDs.

•CHEMICAL RESISTANCE

- 1) Avoid exposure to chemicals as it may attack the LED surface and cause discoloration.
- 2) When washing is required, refer to the following table for the proper chemical to be used. (Immersion time: within 3 minutes at room temperature.)

SOLVENT	ADAPTABILITY
Freon TE	⊙
Chloroethene	×
Isopropyl Alcohol	⊙
Thinner	×
Acetone	×
Trichloroethylene	×

⊙--Usable ×--Do not use.

NOTE: Influences of ultrasonic cleaning of the LED resin body differ depending on such factors as the oscillator output, size of the PC board and the way in which the LED is mounted. Therefore, ultrasonic cleaning should only be performed after confirming there is no problem by conducting a test under practical.

•OTHERS

- 1) Care must be taken to ensure that the reverse voltage will not exceed the absolute maximum rating when using the LEDs with matrix drive.
- 2) Flashing lights have been known to cause discomfort in people; you can prevent this by taking precautions during use. Also, people should be cautious when using equipment that has had LEDs incorporated into it.
- 3) The LEDs described in this brochure are intended to be used for ordinary electronic equipment (such as office equipment, communications equipment, measurement instruments and household appliances). Consult PARA's sales staff in advance for information on the applications in which exceptional quality and reliability are required, particularly when the failure or malfunction of the LEDs may directly jeopardize life or health (such as for airplanes, aerospace, submersible repeaters, nuclear reactor control systems, automobiles, traffic control equipment, life support systems and safety devices).
- 4) User shall not reverse engineer by disassembling or analysis of the LEDs without having prior written consent from PARA. When defective LEDs are found, the User shall inform PARA directly before disassembling or analysis.
- 5) The formal specifications must be exchanged and signed by both parties before large volume purchase begins.
- 6) The appearance and specifications of the product may be modified for improvement without notice.
- 7) Recommended Wave Soldering Profile.

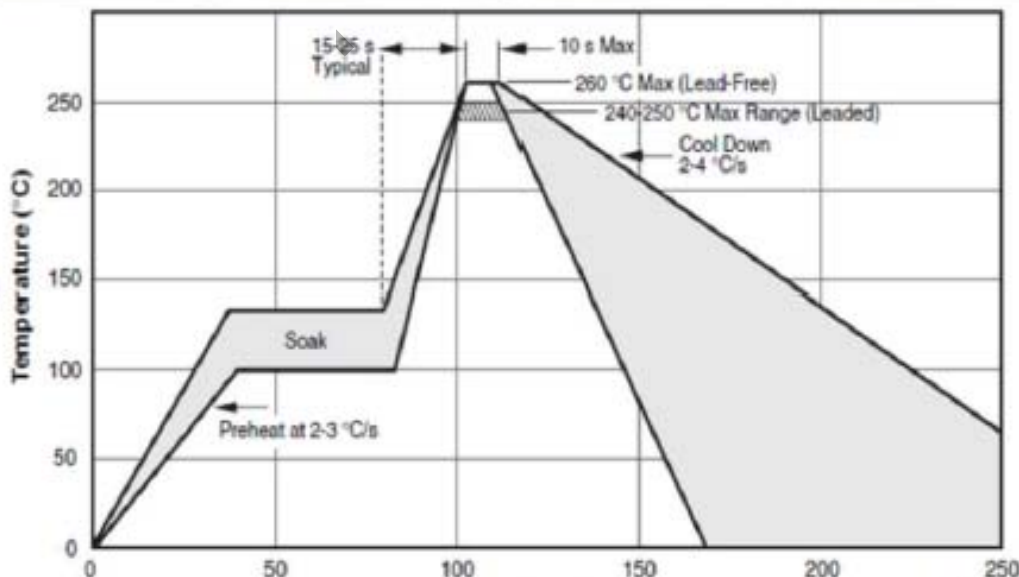



3.0 mm LED LAMP WITH
LHY3303-9A/B-V0 HOLDER

LH33C204D-HTS

REV:B/ 0

L - H 3 3 C 2 0 4 D - HTS

LENGTH

- A: 2.75mm
- B: 3.00mm
- C: 3.20mm
- D: 3.30mm
- E: 3.50mm
- F: 4.00mm
- G: 5.00mm
- H: 18.05mm

Series number

HOLDERS Type

- 1: 1PCS
- 2: 2PCS
- 3: 3PCS
- 4: 4PCS
- 5: 5PCS

- 3: 3mmLAMPS
- 4: 4mmLAMPS
- 5: 5mmLAMPS

NOTE:HTS is a special material for MOXA



**3.0 mm LED LAMP WITH
LHY3303-9A/B-V0 HOLDER**

LH33C204D-HTS

REV:B/ 0

BIN CODE LIST

Luminous Intensity (IV), Unit:mcd@20mA		
Bin Code(Y)	Min	Max
E	3.90	5.50
F	5.50	7.70
G	7.70	10.8
H	10.8	15.1
I	15.1	21.1

Tolerance of each bin are±15%

Luminous Intensity (IV), Unit:mcd@20mA		
Bin Code(G)	Min	Max
C	2.00	2.80
D	2.80	3.90
E	3.90	5.50
F	5.50	7.70
G	7.70	10.8
H	10.8	15.1

Tolerance of each bin are±15%



3.0 mm LED LAMP WITH LHY3303-9A/B-V0 HOLDER

LH33C204D-HTS

REV:B/0

LH33C204D-HTS package rule Note:

- 1、 Each plate of 560 PCS
- 2、 Within each small box 5 plate, quantity is 2800 PCS

PARA LIGHT

LEONA®

UL Acquisition Status of a typical Grade

E46285 (M)
Polyamide (PA66), Type 66 nylon, designated "Leona", furnished in the form of pellets.

Mil Dsg	Color	Minimum thickness (mm)	Flame Class (UL94)	RTI			Hot wire ign.	High amp arc ign.	High volt track rate	Arc resistance (E495)	IEC track (CTI)
				Electrical	Mechanical						
					With Impact	Without impact					
1300S 1300F	All	0.70	V-2	105	75	85	4	0	—	—	—
		1.5	V-2	105	75	85	4	0	—	—	—
		3.0	V-2	105	75	85	3	0	0	5	0
1302S	All	0.75	V-2	120	95	90	4	0	—	—	—
		1.5	V-2	120	95	90	3	0	—	—	—
		3.0	V-2	120	95	100	3	0	0	5	0
1402S 1402F	All	0.71	V-2	130	105	105	4	0	—	—	—
		1.5	V-2	130	105	105	3	0	—	—	—
		3.0	V-2	130	105	105	3	0	0	6	1
1402SH	All	0.69	V-2	120	95	100	4	0	—	—	—
		1.5	V-2	120	95	100	3	0	—	—	—
		3.0	V-2	120	95	100	2	0	0	6	1
13G15	All	0.75	HB	125	110	115	4	0	—	—	—
		1.5	HB	125	110	120	3	0	—	—	—
		3.0	HB	125	110	120	2	0	0	5	0
13G25	All	0.75	HB	125	110	110	4	0	—	—	—
		1.5	HB	125	110	110	3	0	—	—	—
		3.0	HB	125	110	120	2	0	1	5	0
1300G	All	0.75	HB	125	105	110	3	0	—	—	—
		1.5	HB	125	105	110	3	0	—	—	—
		3.0	HB	125	110	120	3	0	1	5	0
13G43	All	0.75	HB	110	110	115	4	0	—	—	—
		1.5	HB	110	110	120	2	0	—	—	—
		3.0	HB	110	110	120	3	0	1	5	0
14G15	All	0.75	HB	65	65	65	—	—	—	—	—
1402G	All	0.71	HB	120	90	110	4	0	—	—	—
		1.5	HB	120	90	120	3	0	—	—	—
		3.0	HB	120	100	125	0	0	1	6	1
14G25 14G33	All	0.75	HB	65	65	65	3	0	—	—	—
		1.5	HB	140	125	140	3	0	—	—	—
		3.0	HB	140	125	140	3	0	0	6	1
14G50	All	0.75	HB	65	65	65	3	0	—	—	—
		1.5	HB	140	125	140	3	0	—	—	—
		3.0	HB	140	125	140	3	0	0	5	0

Mil Dsg	Color	Minimum thickness (mm)	Flame Class (UL94)	RTI			Hot wire ign.	High amp arc ign.	High volt track rate	Arc resistance (D495)	IEC track (CTI)
				Electrical	Mechanical						
					With Impact	Without Impact					
90G50	All	1.5	HB	65	65	65	2	0	—	—	—
		3.0	HB	65	65	65	0	0	0	5	0
93G33	All	1.5	HB	65	65	65	3	0	—	—	—
		3.0	HB	65	65	65	0	0	0	5	0
54G33	All	0.75	HB	125	90	120	3	0	—	—	—
		1.5	HB	125	90	120	2	0	—	—	—
		3.0	HB	125	90	120	0	0	1	6	1
54G43	All	0.80	HB	65	65	65	—	—	—	—	—
1330G	All	0.75	HB	125	105	105	4	0	—	—	—
		1.5	HB	125	105	115	1	0	—	—	—
		3.0	HB	125	105	120	0	0	1	5	0
MR001	All	0.71	HB	105	75	76	4	0	—	—	—
		1.5	HB	105	75	75	3	0	—	—	—
		3.0	HB	105	75	80	3	0	0	6	0
FR200	All	0.71	V-0	105	65	65	3	0	—	—	—
		1.5	V-0	105	65	65	3	0	—	—	—
		3.0	V-0	105	65	65	2	0	0	5	0
FR370	All	0.38	V-0	65	65	65	—	—	—	—	—
		0.75	V-0	130	90	105	4	1	—	—	—
		1.5	V-0	130	105	105	3	0	—	—	—
		3.0	V-0	130	105	105	2	0	0	5	0
FR561	All	0.70	V-0	65	65	65	—	—	—	—	—
		0.75	V-0	130	90	105	4	1	—	—	—
		1.5	V-0	130	105	105	3	0	—	—	—
		3.0	V-0	130	105	105	3	0	0	5	0
FG170	All	0.75	V-0	105	105	105	0	0	—	—	—
		1.5	V-0	105	105	105	0	0	—	—	—
		3.2	V-0	105	105	105	0	0	1	6	3
FG172	NC	0.41	V-0	65	—	65	—	—	—	—	—
		0.50	V-0	130	—	65	0	0	—	—	—
	All	0.75	V-0	130	115	120	0	0	—	—	—
FG173	All	1.5	V-0	130	115	120	0	0	—	—	—
		3.0	V-0	130	—	120	0	0	1	6	2
		0.5	V-0	65	65	65	1	0	—	—	—
		0.72	V-0	65	65	65	0	0	—	—	—
		0.80	V-0	130	65	120	0	0	—	—	—
FG173	All	1.5	V-0	130	65	120	0	0	—	—	—
		3.0	V-0	130	65	120	0	0	3	7	2

ASAHI KASEI CHEMICALS CORP

HIBIYA-MITSUI BLDG, 1-2 YURAKUCHO 1-CHOME, CHIYODA-KU, TOKYO 100-0006 JP

1300S, 1300F

Polyamide 66 (PA66), "Leona", furnished as pellets

Color	Min Thk (mm)	Flame Class	HWI	HAI	RTI Elec	RTI Imp	RTI Str
ALL	0.71	V-2	4	0	105	75	85
	1.5	V-2	4	0	105	75	85
	3.0	V-2	3	0	105	75	85

Comparative Tracking Index (CTI): 0

Dimensional Stability (%): 0

High-Voltage Arc Tracking Rate (HVTR): 0

High Volt, Low Current Arc Resis (D495): 6

Dielectric Strength (kV/mm): -

Volume Resistivity (10xohm-cm): -

UL94 small-scale test data does not pertain to building materials, furnishings and related contents. UL94 small-scale test data is intended solely for determining the flammability of plastic materials used in the components and parts of end-product devices and appliances, where the acceptability of the combination is determined by ULI.

Report Date: 7/11/1972

Underwriters Laboratories Inc®

Component Plastics

IEC and ISO Test Methods

Test Name	Test Method	Units	Thickness Tested (mm)	Value
IEC Flammability	IEC 60695-11-10	Class (color)	0.71	V-2 (ALL)
			1.5	V-2 (ALL)
			3.0	V-2 (ALL)
Glow-Wire Flammability (GWFI)	IEC 60695-2-12	C	-	-
Glow-Wire Ignition (GWIT)	IEC 60695-2-13	C	-	-
IEC Comparative Tracking Index	IEC 60112	Volts (Max)	-	-
IEC Ball Pressure	IEC 60695-10-2	C	-	-
ISO Heat Deflection (1.80 MPa)	ISO 75-2	C	-	-

ARA LIGHT

塑膠材料符合性保證書
CERTIFICATE OF COMPLIANCE OF PLASTIC MATERIAL

供應商

VENDER

光鼎電子股份有限公司

料號

PART NUMBER

品名

PART DESCRIPTION

光鼎 holder 產品

數量/訂單號碼

QUANTITY/P.O. NO.

出貨日期

SHIPPING DATE

原料製造商

MATERIAL SUPPLIER

连云港光鼎电子有限公司

原料品名/型號/規格

MATERIAL DESCRIPTION / MODEL / SPEC

光鼎holder產品

原料 UL 號碼

MATERIAL UL FILE NUMBER

E48285

原料防火等級

MATERIAL FLAMMABILITY CLASS

V-2

供應商保證 VENDER GUARANTY

1. 本批產品確實符合 UL 跟蹤檢驗服務程序(FUS)的要求，確實依上述規格供應，若有變更冒替，本公司願負賠償之責。

FOR THIS P.O., IF THERE IS ANY DEVIATION TO THE LIST ABOVE, WE WILL BE RESPONSIBLE FOR THE COST INCURRED.

2. 本批產品使用的回收料(次料)不超過 25%

THE REPROCESSED MATERIAL USED IN THIS SHIPMENT DOES NOT EXCEED 25%

供應商簽章及蓋公司章

VENDER SIGNATURE & COMPANY SEAL

李景儀

