

DATA SHEET

PART NO.: L-S193WDT-2A-YY-U1

REV: A/1

CUSTOMER'S APPROVAL: _____

DCC: _____

DRAWING NO. : DS-51-19-076

DATE : 2021-11-20

Page

1

1.6*0.75*1.1mm SMD LED

Part No.: L-S193WDT-2A-YY-U1

REV:A/1

● PACKAGE OUTLINE DIMENSIONS

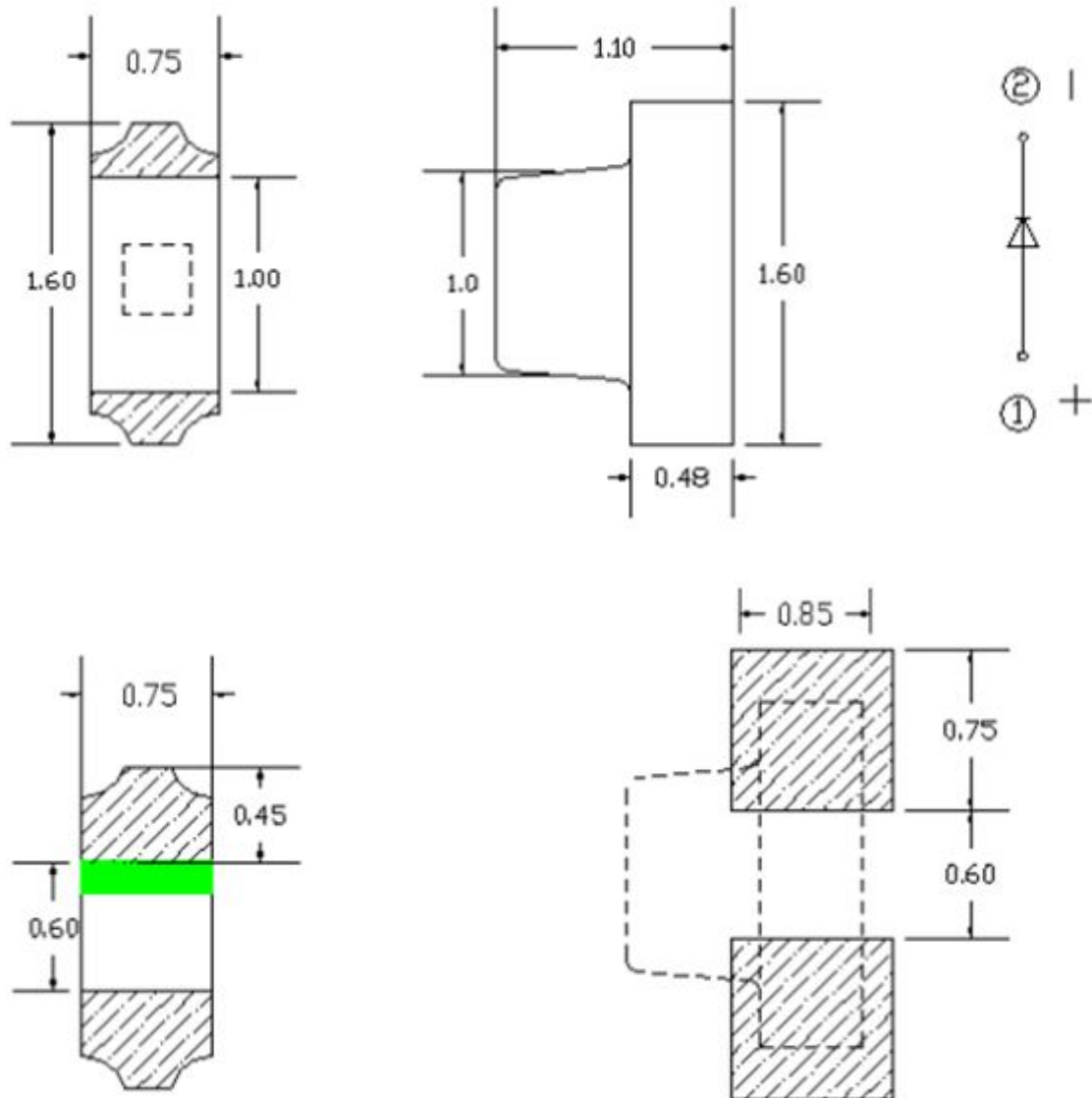

Notes:

1. All dimensions are in millimeters.
2. Tolerance is $\pm 0.1\text{mm}$ (.004") unless otherwise noted.

1.6*0.75*1.1mm SMD LED

Part No.: L-S193WDT-2A-YY-U1

REV:A/1

● Features

- Package (L/W/H) : 1.6*0.75*1.1 mm.
- Color: White light
- Lens: Yellow planar colloid
- Meet ROHS, Green Product
- Compatible With SMT Automatic Equipment
- Compatible With Infrared Reflow Solder Process
- EIA STD package.

● Absolute Maximum Ratings (Ta=25°C)

Parameter	Symbol	Rating	Unit
Power Dissipation	Pd	100	mW
Peak Forward Current	IFP	60	mA
DC Forward Current	IF	30	mA
Backward Voltage	VR	5	V
Operating Temperature Range	Topr	-40°C ~ +85°C	
Storage Temperature Range	Tstg	-40°C ~ +85°C	
Soldering Condition	Tsol	Reflow soldering : 260°C , 10s Hand soldering : 300°C , 3s	

1.6*0.75*1.1mm SMD LED

Part No.: L-S193WDT-2A-YY-U1

REV:A/1

● Electrical Optical Characteristics (Ta=25°C)

Parameter	Symbol	Min.	Typ.	Max.	Unit	Test Condition
Light Intensity	IV	58	100	145	mcd	IF = 2mA
Viewing Angle	2θ1/2	---	120	---	deg	IF = 2mA
CIE 1931 Coordinate	X	---	0.248	---		IF = 2mA
	Y	---	0.22	---		IF = 2mA
Forward Voltage	VF	2.5	2.8	3.0	V	IF = 2mA
Backward Voltage	IR	---	---	5	μA	VR = 5V
Spectral Line Half-Width	Δλ	---	15	---	nm	IF = 2mA
Color Temperature	CCT	10413	100000	More than 100000	K	IF = 2mA

● Bin Code List

Brightness Bin specifications

Bin	Min	Max	Unit	Condition
P17	58	70	mcd	IF = 2mA
P18	70	85		
P19	85	100		
P20	100	120		
P21	120	145		

Notes: Tolerance of Luminous Intensity: ± 10%

1.6*0.75*1.1mm SMD LED

Part No.: L-S193WDT-2A-YY-U1

REV:A/1

Voltage sub Bin specification

Bin	Min	Max	Unit	Condition
VL	2.5	2.6	V	IF = 2mA
VM	2.6	2.7		
VN	2.7	2.8		
VO	2.8	2.9		
VP	2.9	3.0		

Notes: Tolerance of Forward Voltage: $\pm 0.05V$

Color distinguishes Bin specifications

BIN	X1	Y1	X2	Y2	X3	Y3	X4	Y4	CCT(K)
GV1	0.2026	0.1641	0.2206	0.1554	0.2333	0.1814	0.2153	0.1902	More than 100000
GV2	0.2153	0.1902	0.2333	0.1814	0.246	0.2074	0.228	0.2163	More than 100000
GV3	0.228	0.2163	0.246	0.2074	0.2587	0.2335	0.2407	0.2424	31592- More than 100000
GV4	0.2407	0.2424	0.2587	0.2335	0.2714	0.2596	0.2534	0.2685	15130-31592
GV5	0.2534	0.2685	0.2714	0.2596	0.2841	0.2857	0.2661	0.2946	10413-15130

Notes: color coordinate tolerance: ± 0.005

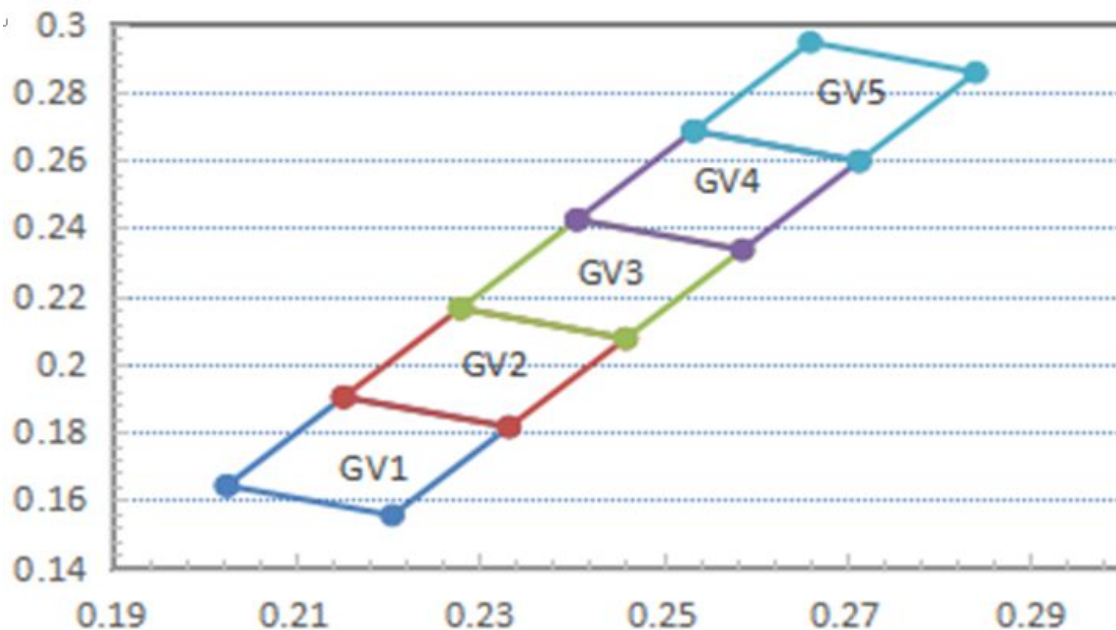

1.6*0.75*1.1mm SMD LED

Part No.: L-S193WDT-2A-YY-U1

REV:A/1

● Typical Electrical-Optical Characteristics Curves

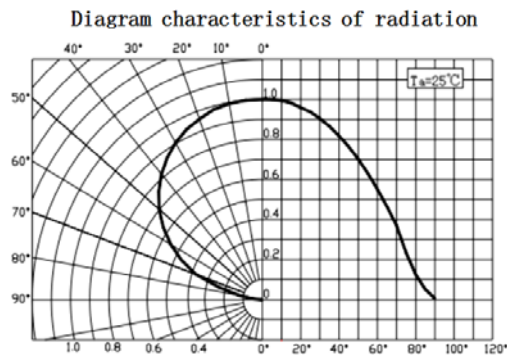
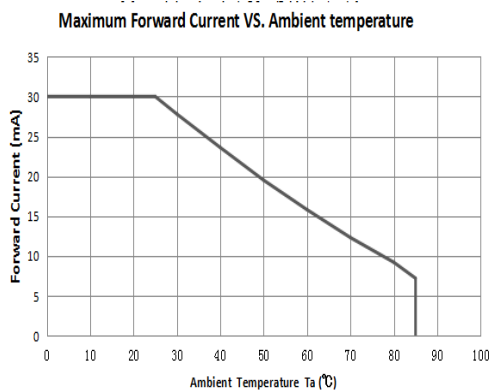
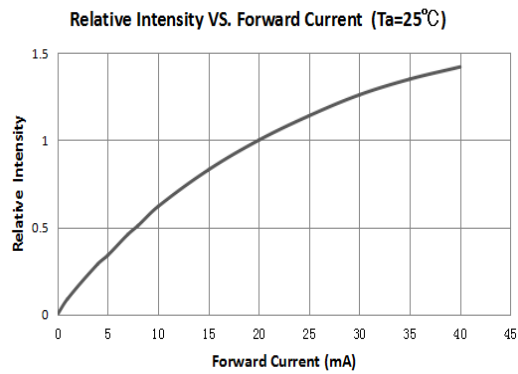
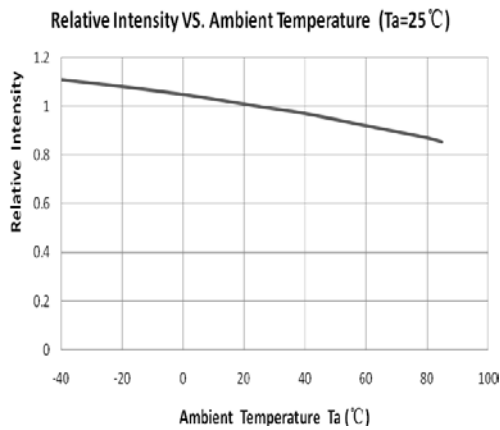
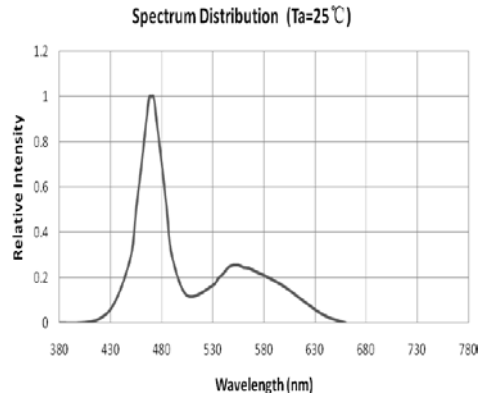
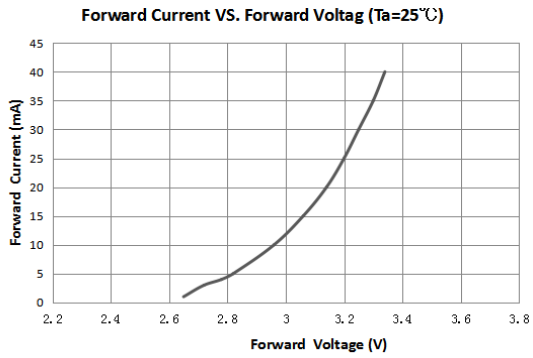

1.6*0.75*1.1mm SMD LED

Part No.: L-S193WDT-2A-YY-U1

REV:A/1

● Reel And Tape Dimensions

Packing quantity: 4000 PCS/rolls

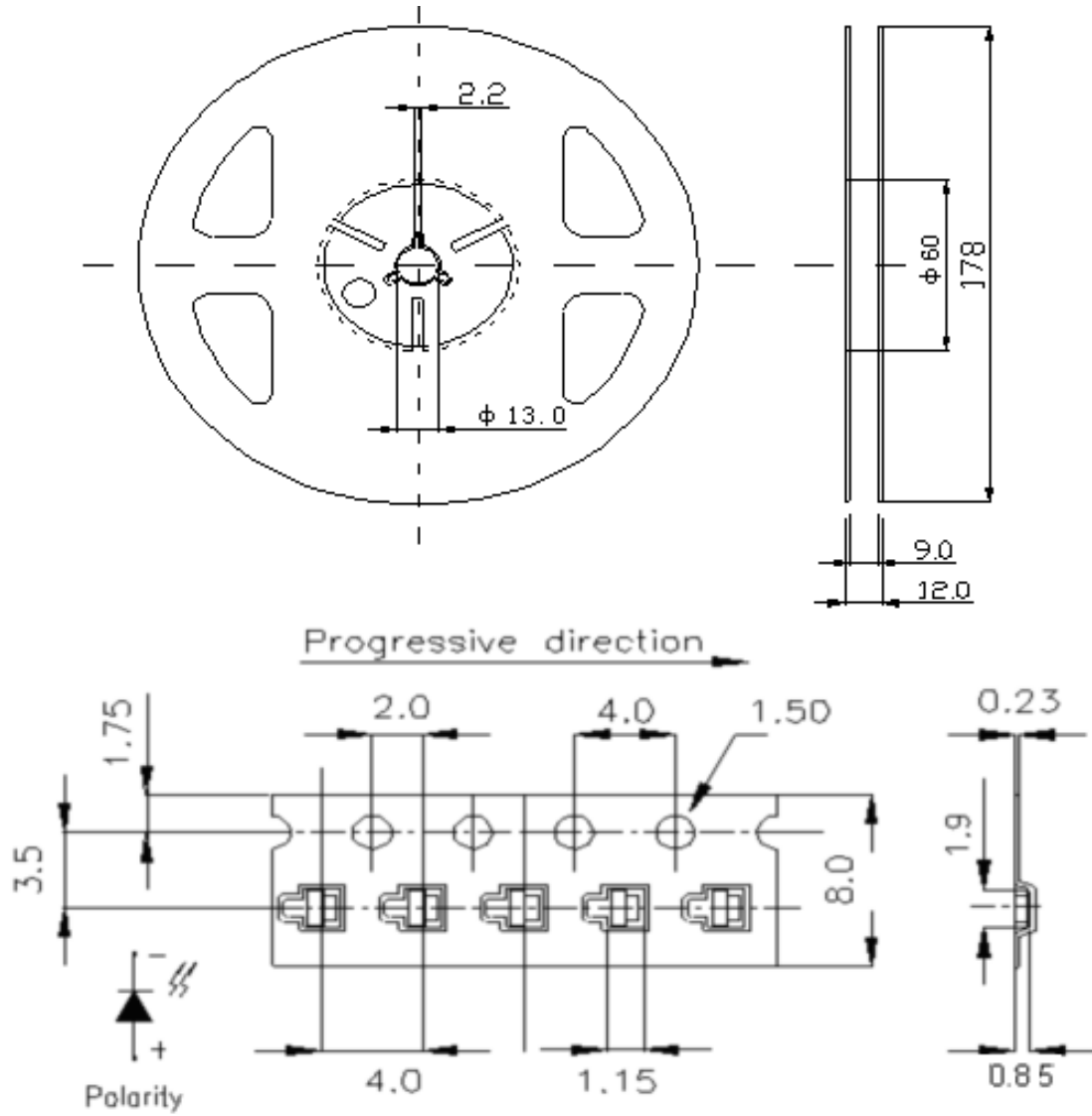

- Notes: 1. All dimensions are in millimeters.
2. Tolerance is ± 0.1 mm unless otherwise noted.

1.6*0.75*1.1mm SMD LED

Part No.: L-S193WDT-2A-YY-U1

REV:A/1

● Label Explanation

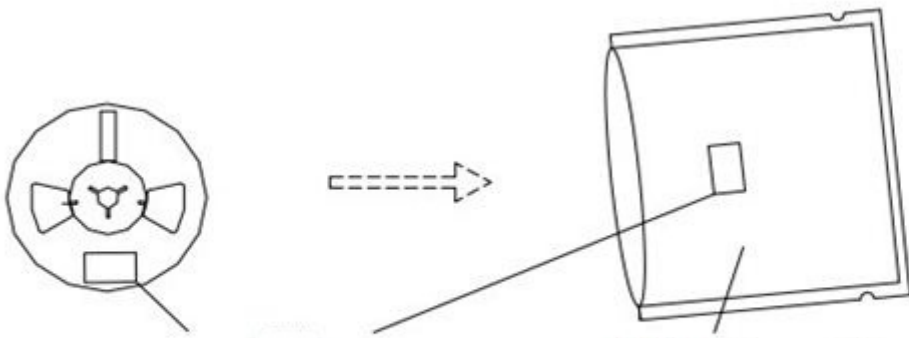

The label

Anti-static, moisture-proof aluminum foil bag

● Soldering Profile Suggested

lead-free solder

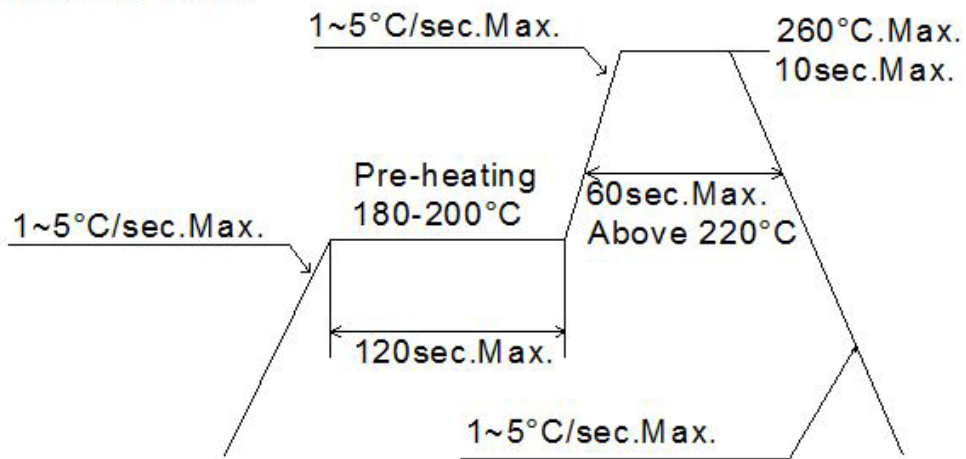

1.6*0.75*1.1mm SMD LED

Part No.: L-S193WDT-2A-YY-U1

REV:A/1

● Cautions

1.welding

- 1.1 SMD LED is soft and easy to damage the luminous surface and plastic shell by external force. It should be handled lightly when welding
- 1.2 It is recommended to use soldering flux with tin wash type, reflow soldering according to the condition of reflux curve, reflow twice at most, ensure the LED luminous surface is clean, foreign matter will affect the luminous color.
- 1.3 Manual welding is only recommended for repair and heavy industry;The maximum welding temperature should not exceed 300 degrees, and must be completed within 3 seconds (manual welding can only be welded once) soldering iron maximum power should not exceed 25W.
- 1.4 During the soldering process, do not touch the lens at high temperature , After soldering, any mechanical force on the lens or any excessive vibration shall not be accepted to apply, also the circuit board shall not be bent as well.
- 1.5 Please do not use different BIN LED on the same product, otherwise it may cause serious color difference.

2.cleaning

- 2.1 No ultrasonic cleaning. It is recommended to use isopropyl alcohol, pure alcohol to wipe or soak, not more than 1 minute, and leave at room temperature for 15 minutes before use. After cleaning, make sure the LED luminous surface is clean and the foreign matter will affect the luminous color.
- 2.2 Avoid touching or contaminating the water, trichloroethylene, acetone, sulfide, nitride, acid, alkali, and salts that can damage leds.

3.embedment

- 3.1 Volatile substances to leach into the LED inside, photons in electricity and heat conditions, will lead to the LED color, thus causing serious droop, it is forbidden to use any of the LED device performance or reliability of harmful substances or materials, for a specific purpose and use of the environment, advice on all the material and the material compatibility test.When attaching LED, do not use adhesive that can produce volatile organic gas.
- 3.2 It is recommended to light up for 168 hours at room temperature for a small amount of test before using normal filling and sealing glue.

1.6*0.75*1.1mm SMD LED

Part No.: L-S193WDT-2A-YY-U1

REV:A/1

4. save

- 4.1 Before opening the package, LED should be stored in a temperature 30 °C or below, under RH60 % relative humidity, used in a year.
- 4.2 LED is humidity sensitive element, element to avoid moisture absorption, after open the packing, the LED should be in temperature 30 °C or below, within 60% relative humidity, using time 7 days. After moisture absorption, LED may crack when reflow soldering, influence the luminous color. For bulk is not used, please deal with the tide (for package product: bake 60 °C +/- 5 °C / 24 h. For bulk goods: baking 105 °C + 5 °C, 1 hours), and then save after sealed with aluminum foil bag or stored in nitrogen moistureproof enclosure
- 4.3 Avoid the presence of acid, alkali and corrosive gas in the preservation environment, and avoid strong vibration and strong magnetic field.

5. electrostatic

- 5.1 Static electricity or peak surge voltage will damage the LED, avoiding instantaneous voltage when the lamp is turned on or off.
- 5.2 It is recommended to wear anti-static wrist bands, anti-static gloves and anti-static shoes when using LED. The equipment and instruments used are properly grounded. After the LED was damaged, the leakage current increased obviously, the forward voltage of low current became lower, and the low current point did not light, etc.

6. test

- 6.1 LED shall be driven at rated current, and shall be protected by current-limiting resistance in the circuit. Otherwise, slight voltage changes will cause large current changes, which will damage the LED.
- 6.2 When the circuit is on or off, avoid sudden surge voltage. Otherwise, the LED will be burnt out
LED: / Please check the LED as shown

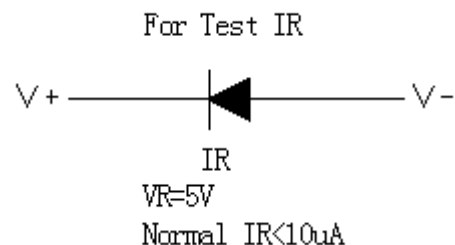
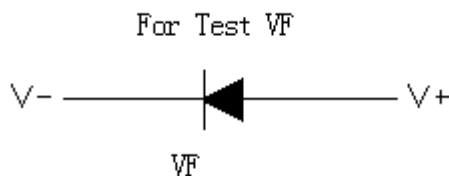

1.6*0.75*1.1mm SMD LED

Part No.: L-S193WDT-2A-YY-U1

REV:A/1

- 6.3 If the forward voltage V_F is too high or the reverse voltage V_R is too high, the LED will be damaged.
- 6.4 When lighting or testing the LED, the reverse voltage added on both ends of the LED shall not be higher than 5V, otherwise it is easy to damage the LED.
- 6.5 LED luminous color will vary slightly with the working current. It is suggested that resistance and LED should be used in series in the design

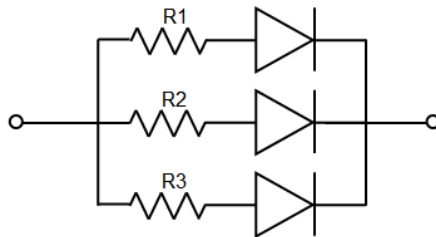

- 6.6 LED is easy to change due to its own heat and changes in the temperature of the environment. The increase in temperature will reduce the luminous efficiency of LED, which will affect the luminous color. Heat dissipation should be fully considered in the design